

81 Series High Performance Composite Video Distribution Amplifier Manual Rev D

Part Number

81-111-104-A (1x4 SE)	81-111-108-A (1x8 SE)
81-121-104-A (1x4 Diff)	81-121-108-A (1x8 Diff)
81-131-104-A (1x4 SE LT)	81-131-108-A (1x8 SE LT)
81-141-104-A (1x4 Diff LT)	81-141-108-A (1x8 Diff LT)

Video Accessory Corporation
1243 Sherman Drive, Suite 8
Longmont, Colorado 80501
303-443-1319

www.vac-brick.com

Two Year Limited Warranty

All Video Accessory Corporation (VAC) products have a full two year limited warranty. Exclusions to the warranty include but are not limited to damage to external components, power LED failure where the product continues to function, and electrical damage due to lightning. The warranty shall be void if any alteration or repair of a VAC product is attempted by anyone not authorized by VAC. This warranty is expressly in lieu of all other warranties express or implied, including warranties of merchantability and fitness for use, and of all other obligations or liabilities on the part of VAC, and it neither assumes nor authorizes any other person to assume for it any liability in connection with the sale of this product. This warranty shall not apply to the product or any part thereof subjected to accident, negligence, alteration, abuse, or misuse. No warranty whatsoever is made with respect to accessories or parts supplied by anyone other than VAC, and this warranty shall extend only to the original purchaser of this product. The warranty provided in this article is exclusive and in lieu of, and buyer hereby waives, all other remedies, express or implied, arising by law or otherwise, including consequential damages, whether or not occasioned by negligence of VAC. This warranty shall not be extended, altered or varied except by written instrument signed by VAC and buyer, and shall only apply within the boundaries of the continental United States. Liability of VAC is limited to repair or replacement at the option of VAC. Warranty work is to be sent to VAC. Freight charges will be the responsibility of the purchaser.

Table of Contents

1	Overview	1
2	Basic Functions	1
3	Power Requirements	1
4	Overall Specifications	3
5	Packages	4

Document History

Rev	Date	Action
A	April 27, 2012	Initial Release
B	Nov 29, 2012	Corrected Power description section Added epoxy UL recognition to specifications
C	June 4, 2014	Power connector moved closest to mounting on multi-layer bricks
D	Nov 10, 2014	Updated specification sheet to remove TBDs

1 Overview

The 81 Series Composite Distribution Amplifiers “VDA’s” include in this manual provide a way to distribute one composite video signal to up to four, eight, twelve, or sixteen other devices.

- 81-111-104 (1X4 Single Ended Input)
- 81-121-104 (1X4 Differential Input)
- 81-131-104 (1X4 Single Ended Input, w/ Loop-Through)
- 81-141-104 (1X4 Differential Input, w/ Loop-Through)
- 81-111-108 (1X8 Single Ended Input)
- 81-121-108 (1X8 Differential Input)
- 81-131-108 (1X8 Single Ended Input, w/ Loop-Through)
- 81-141-108 (1X8 Differential Input, w/ Loop-Through)

The internal power supply is fully isolated to permit the user to control ground loops. The power connection has an integrated threaded/screw flange for shock and high vibration environments.

2 Basic Functions

All video input and output connections use precision 75Ω BNC connectors. Loop-Thru (LT) models terminate the input signal externally using the Loop-Out connector. VAC includes a 75Ω BNC terminator for all units configured with the Loop-Through option.

Output signals are **unity gain** (x1) and buffered using very high bandwidth amplifiers to duplicate the input signal. Each output is 75Ω series terminated.

3 Power Requirements

These units have an internal switching supply that isolates supply power from the internal power and I/O. Units will operate correctly when powered by 10-24 VAC or 10-32 VDC. Units are equipped with full wave rectification, so power may be applied between Pins 1 & 2 using either polarity.

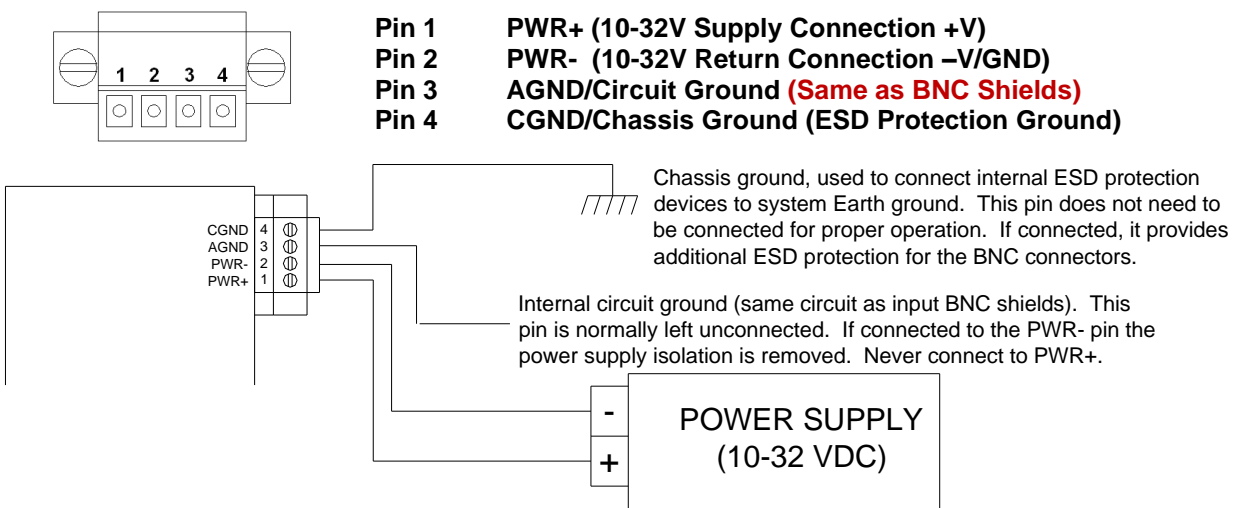

Internal Circuit ground (AGND/Pin-3) is the ground reference for the internal circuits. It is NOT the input voltage return path of pins 1 and 2. The user has the option of floating internal circuits, with respect to any system ground, by not connecting to this pin. The user also has the option to connect the circuit ground to the chassis ground or the input power ground (or both). This power connector pin-out permits the user to define the grounding environment the unit is used in.

Chassis ground (CGND/Pin-4) is connected to internal ESD protection devices. The chassis ground does not need to be connected for proper operation. Secondary ESD protection connections exist between the input and output video signals and internal circuit ground.

The power connector (J7) is a 4 pin 3.5mm center header (Phoenix Contact #1897267) and mating power plug (Phoenix Contact #1847071) with screw flanges for vibration and shock resistance.

The unit has a LED (green) to show power is connected and unit is operational.

4 Overall Specifications

Video Format:	NTSC/PAL
Inputs:	BNC
Input Termination:	75 Ω , Single Ended (SE) 75 Ω , Differential (Diff) External (LT)
Input Levels:	0.25 – 2.2 Vpp (RS-170)
Input Coupling:	DC
Input Bandwidth:	DC-440 MHz @-3dB (1 Vpp input signal)
Outputs:	BNC
Output Termination:	75 Ω (series)
Output Gain:	Unity (1x)
Power LED:	Green (Indicates unit running)
Operating Temperature Range:	-40C to +85C
Power:	10-28V AC, 10-32V DC (either polarity on PWR connector)
Supply Current:	81-111-104: 121 mA @ 12 VDC 81-131-104: 77 mA @ 12 VDC
Power Connector:	3.5mm 4 pin terminal block (Phoenix Contact #1843813) Mating plug (Phoenix Contact #1847071)
Package Dimensions:	1x4: 4.4" x 2.2" x 0.65" (WxDxH) 1x8 : 4.4" x 2.2" x 1.4"
Mounting:	Two 6-32 threaded inserts
Weight:	81-111-104: 6.4 oz 81-131-104: 6.6 oz
Package:	Epoxy/Encapsulation UL 94 V-O & UL 94 5VA rated.
Options:	Contact VAC for individual and multiple brick mounting solutions.

5 Packages

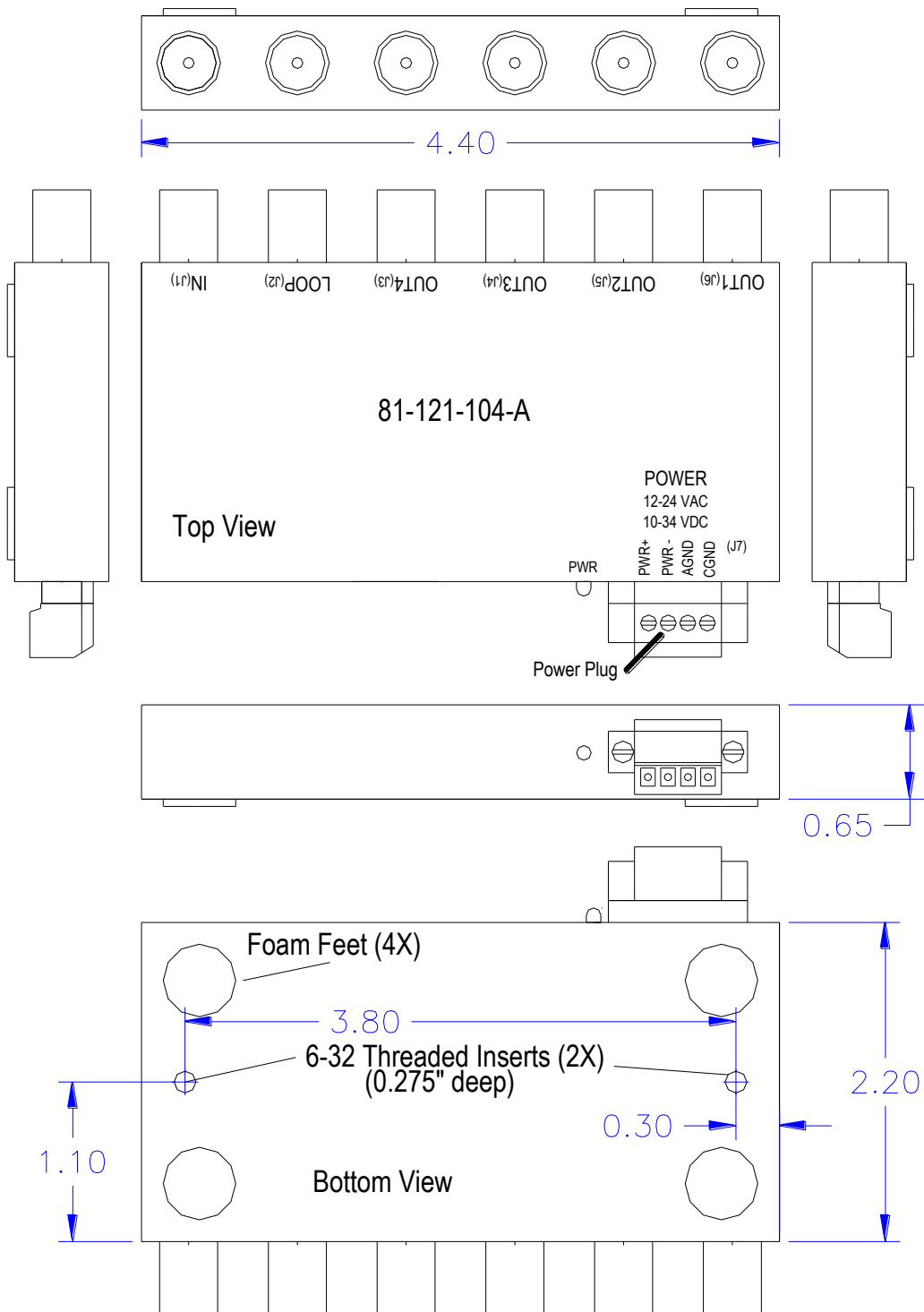

Figure 1: 81-121-104-A 1x4 w/ Loop-thru
81-111-104A (Loop Connector not present)

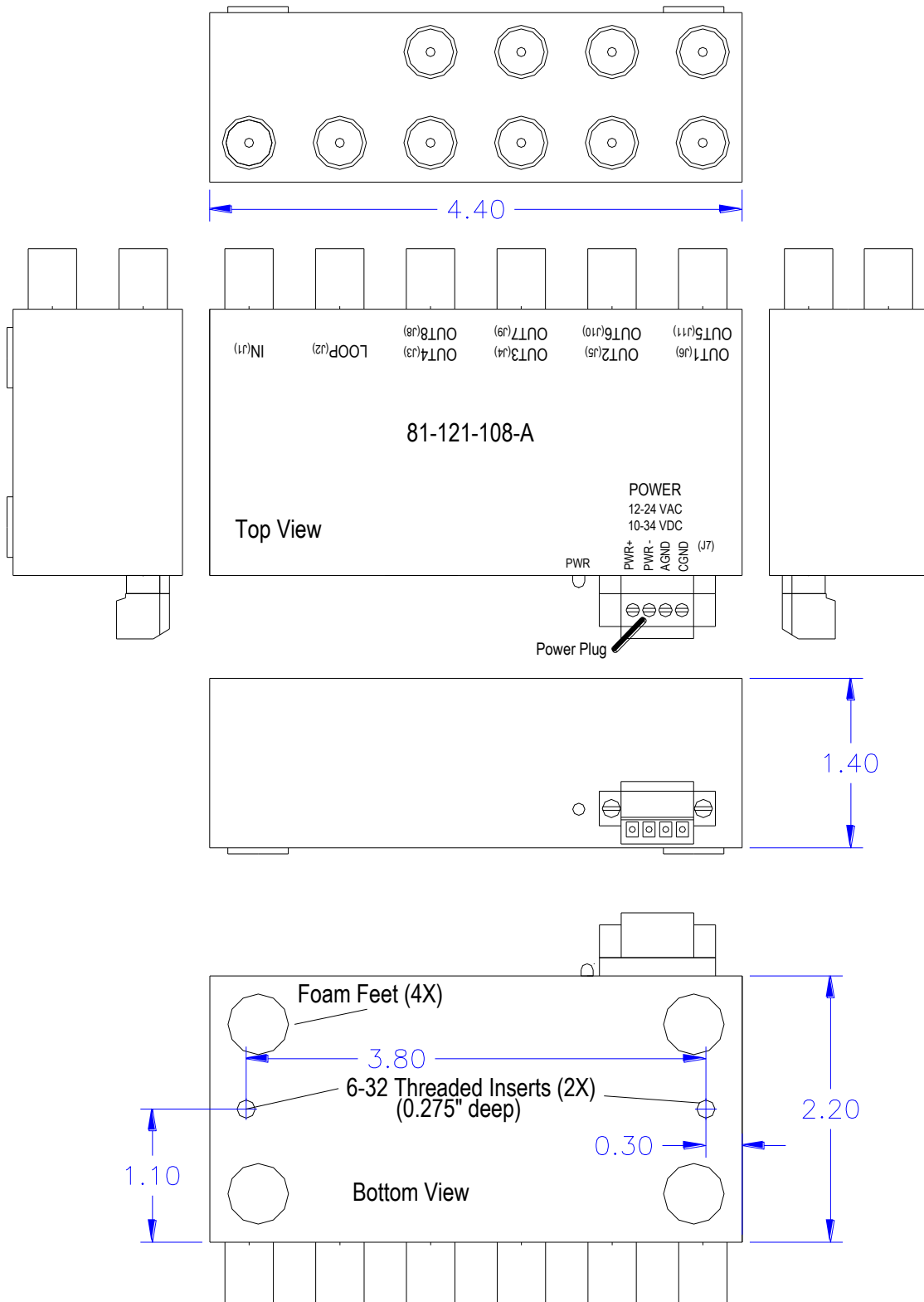

Figure 2: 81-121-108-A 1x8 w/ Loop-thru
81-111-108A (Loop Connector not present)